

## 2SK3047

## Silicon N-Channel Power F-MOS FET

## ■ Features

- Avalanche energy capacity guaranteed: EAS > 15mJ
- $V_{GSS} = \pm 30V$  guaranteed
- High-speed switching:  $t_f = 25ns$
- No secondary breakdown

## ■ Applications

- Contactless relay
- Diving circuit for a solenoid
- Driving circuit for a motor
- Control equipment
- Switching power supply

■ Absolute Maximum Ratings ( $T_C = 25^\circ C$ )

Parameter	Symbol	Ratings	Unit
Drain to Source breakdown voltage	$V_{DSS}$	800	V
Gate to Source voltage	$V_{GSS}$	$\pm 30$	V
Drain current	DC	$I_D$	$\pm 2$ A
	Pulse	$I_{DP}$	$\pm 4$ A
Avalanche energy capacity	EAS*	15	mJ
Allowable power dissipation	$T_C = 25^\circ C$	$P_D$	30
	$T_a = 25^\circ C$		2
Channel temperature	$T_{ch}$	150	$^\circ C$
Storage temperature	$T_{stg}$	-55 to +150	$^\circ C$

\*  $L = 5mH$ ,  $I_L = 2.45A$ ,  $V_{DD} = 50V$ , 1 pulse

■ Electrical Characteristics ( $T_C = 25^\circ C$ )

Parameter	Symbol	Conditions	min	typ	max	Unit	
Drain to Source cut-off current	$I_{DSS}$	$V_{DS} = 640V$ , $V_{GS} = 0$			0.1	mA	
Gate to Source leakage current	$I_{GSS}$	$V_{GS} = \pm 30V$ , $V_{DS} = 0$			$\pm 1$	$\mu A$	
Drain to Source breakdown voltage	$V_{DSS}$	$I_D = 1mA$ , $V_{GS} = 0$	800			V	
Gate threshold voltage	$V_{th}$	$V_{DS} = 25V$ , $I_D = 1mA$	2		5	V	
Drain to Source ON-resistance	$R_{DS(on)}$	$V_{GS} = 10V$ , $I_D = 1A$		4.8	7	$\Omega$	
Forward transfer admittance	$ Y_{fs} $	$V_{DS} = 25V$ , $I_D = 1A$	0.7	1.1		S	
Diode forward voltage	$V_{DSF}$	$I_{DR} = 2A$ , $V_{GS} = 0$			-1.3	V	
Input capacitance (Common Source)	$C_{iss}$	$V_{DS} = 20V$ , $V_{GS} = 0$ , $f = 1MHz$		350		pF	
Output capacitance (Common Source)	$C_{oss}$				60		pF
Reverse transfer capacitance (Common Source)	$C_{rss}$				25		pF
Turn-on time (delay time)	$t_{d(on)}$	$V_{GS} = 10V$ , $I_D = 1A$		15		ns	
Rise time	$t_r$				20		ns
Turn-off time (delay time)	$t_{d(off)}$		$V_{DD} = 200V$ , $R_L = 200\Omega$		60		ns
Fall time	$t_f$				25		ns

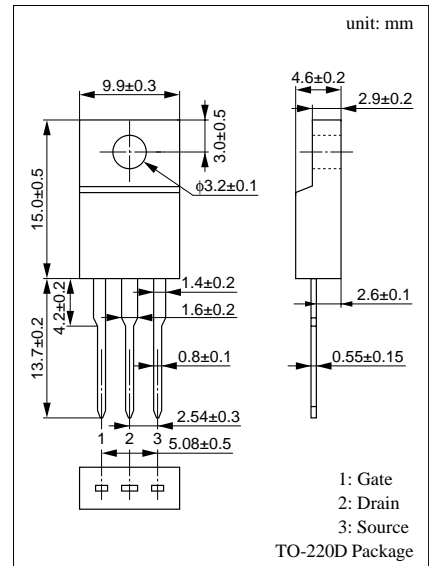

Area of safe operation (ASO)

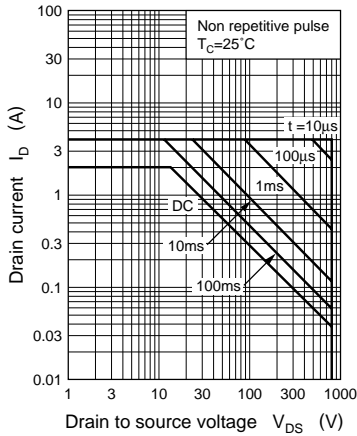

$P_D - T_a$

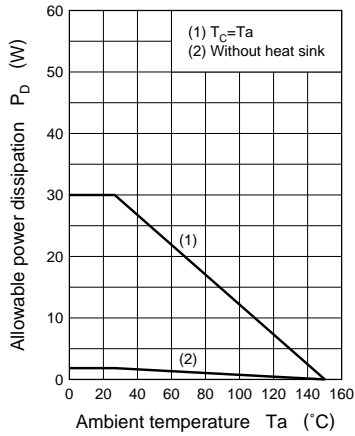

EAS —  $T_j$

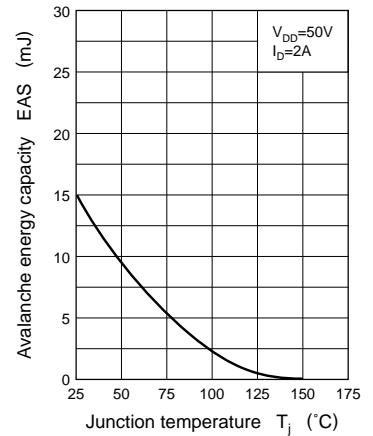

$I_D - V_{DS}$

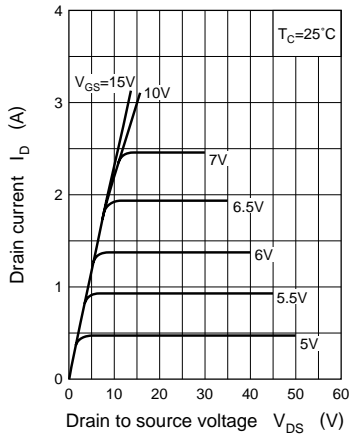

$I_D - V_{GS}$

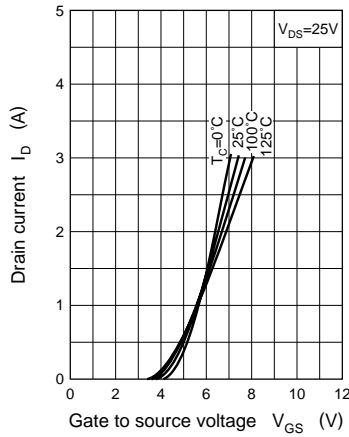

$V_{th} - T_C$

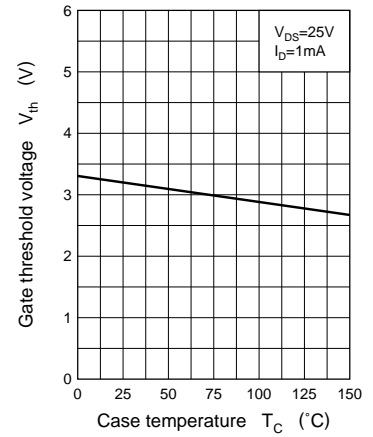

$R_{DS(on)} - I_D$

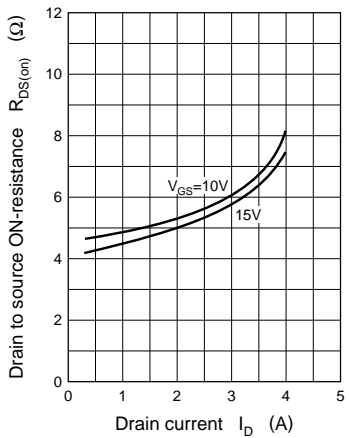

$|Y_{fs}| - I_D$

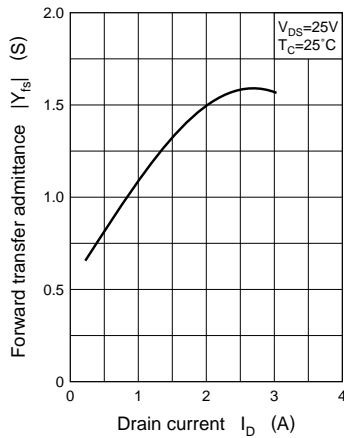

$C_{iss}, C_{oss}, C_{rss} - V_{DS}$

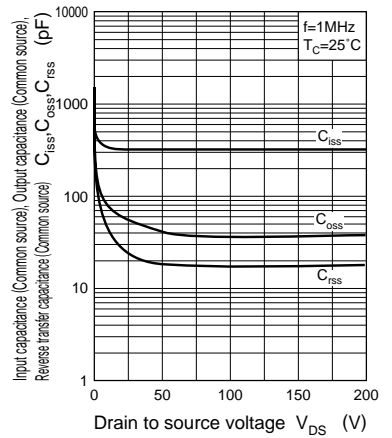

$V_{DS}, V_{GS} - Q_g$

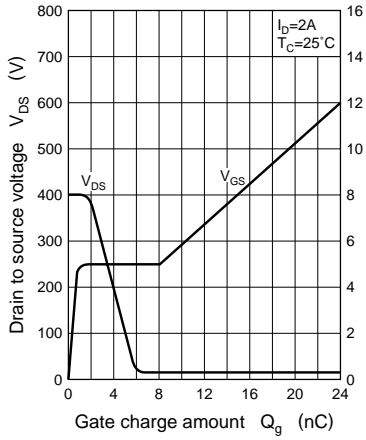

$t_{d(on)}, t_r, t_f, t_{d(off)} - I_D$

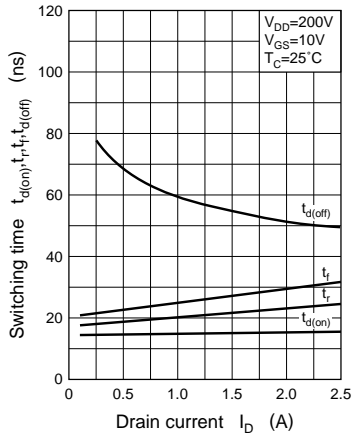

$R_{th(t)} - t$

